

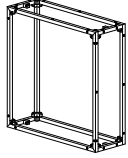

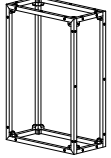

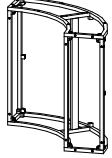
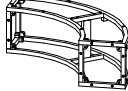
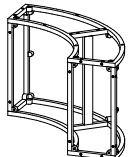
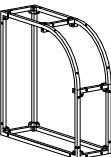
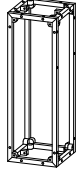

T-wave

ティーウエーブ

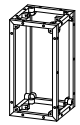
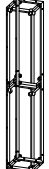
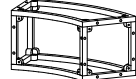
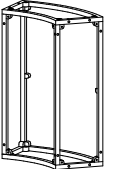
Contents

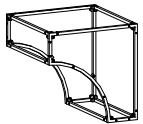
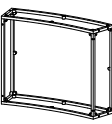
T-wave A		T-wave A-500		T-wave B		T-wave B-250	
T-03		T-03		T-04		T-04	
T-wave B-500		T-wave C		T-wave D		T-wave D-250	
T-04		T-04		T-05		T-05	
T-wave D-500		T-wave D-1500		T-wave E-250		T-wave E-750	
T-05		T-05		T-05		T-05	
T-wave F		T-wave F-750		T-wave G		T-wave G-250	
T-06		T-06		T-06		T-06	
T-wave H		T-wave I		T-wave K		T-wave L-250	
T-06		T-06		T-07		T-07	

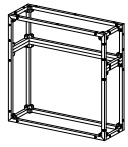
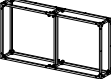
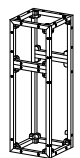
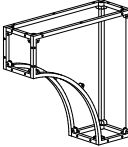
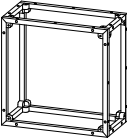
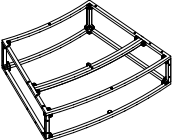
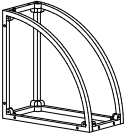
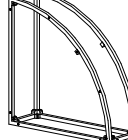
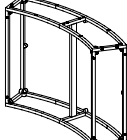
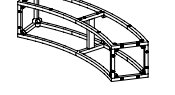
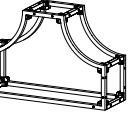
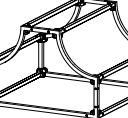
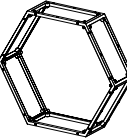
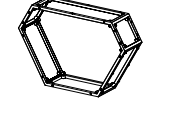
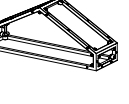
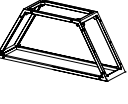
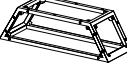
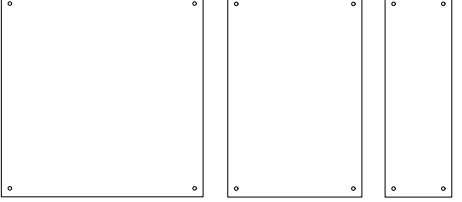
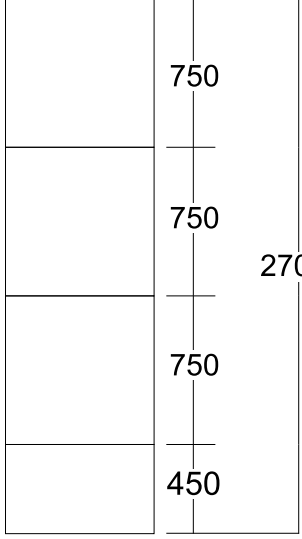
<p>T-wave M-500</p>  <p>T-07</p>		<p>T-wave OW-250</p>  <p>T-07</p>		<p>T-wave R-500</p>  <p>T-08</p>		<p>T-wave R-750</p>  <p>T-08</p>	
<p>T-wave S</p>  <p>T-08</p>		<p>T-wave S-250</p>  <p>T-08</p>		<p>T-wave TR-250</p>  <p>T-08</p>		<p>T-wave TR-750</p>  <p>T-08</p>	
<p>T-wave Y-250</p>  <p>T-09</p>		<p>T-wave YB-250</p>  <p>T-09</p>		<p>T-wave YC-250</p>  <p>T-09</p>		<p>T-wave YD-250</p>  <p>T-09</p>	
<p>T-wave YF-250</p>  <p>T-09</p>		<p>LEDPANEL T-10</p> <hr/> <p>X-BAR T-10</p>		<p>高さ2700にも対応可能(T-wave A・B・D・E・G用)</p>			
<p>PANEL T-12,13,14</p> 		 <p>調整フレーム→</p>					

T-wave A / A-500

P-0 の使用パネルはT-12~T-14に記載してあります。

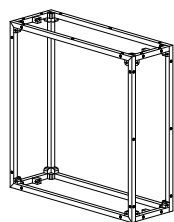

T-wave A

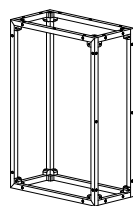

T-wave A-500

品名	重量 (kg)
T-wave A	4.55
T-wave A-500	4.42

仕様サイズ(素材: A6061-T5 / 主材断面: □22×T3.3)

上面フレーム (A) P-3
top view

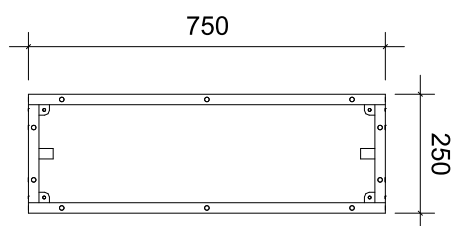

上面フレーム (A-500) P-5
top view

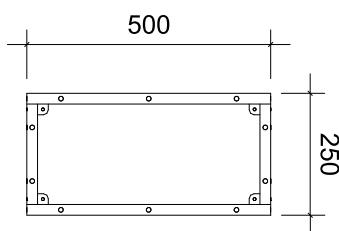

正面フレーム (A) P-1
front view

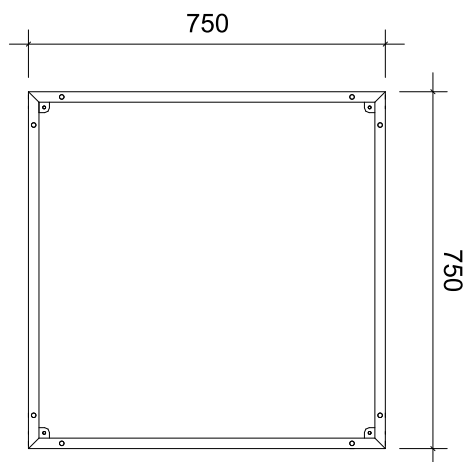

正面フレーム (A-500) P-2
front view

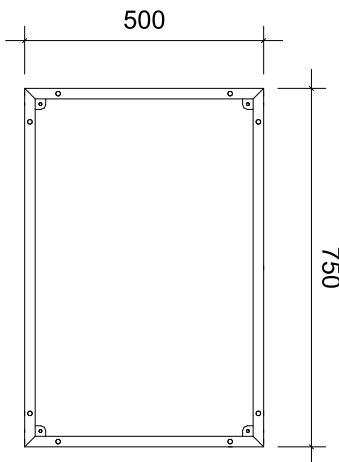

側面フレーム (A/A-500) P-3
side view



A-2250 P-7

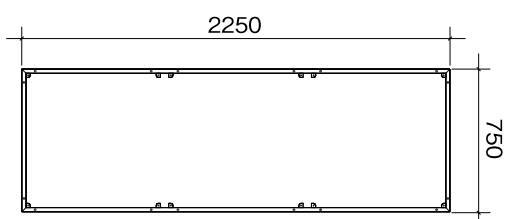

A-3000 P-8

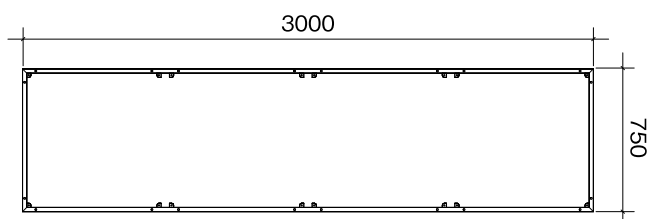

T-wave B / B-250 / B-500 (ø1500 1/4)

P-0 の使用パネルはT-12~T-14に記載してあります。

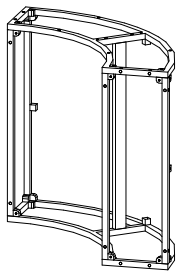

T-wave B

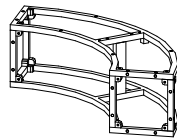

T-wave B-250

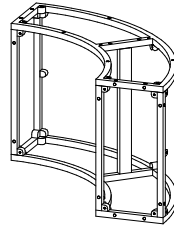

T-wave B-500

品名	重量 (kg)
T-wave B	6.39
T-wave B-250	5.05
T-wave B-500	6.06

仕様サイズ(素材: A6061-T5 / 主材断面: □22×T3.3)

側面フレーム P-3
side view

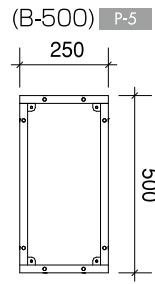
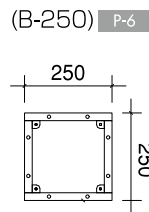
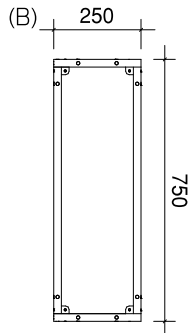

上面フレーム (B/B-250/B-500) P-9
top view

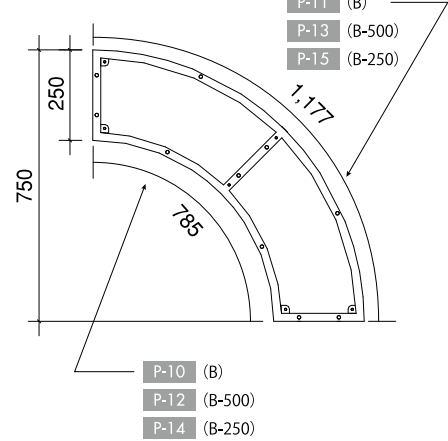

T-wave C

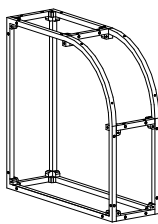

品名	重量 (kg)
T-wave C	4.63

仕様サイズ(素材: A6061-T5 / 主材断面: □22×T3.3)

側面フレーム P-3
side view

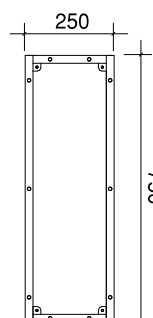

正面フレーム P-21
front view

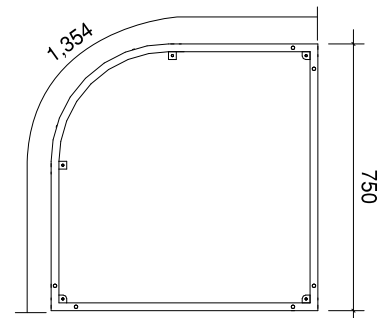

上面フレーム P-22
top view

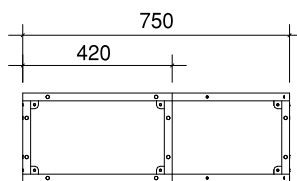

最大パネル厚 5mm / 穴サイズ φ11mm

T-wave D / D-250 / D-500 / D-1500

P-0 の使用パネルはT-12~T-14に記載してあります。

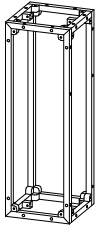

T-wave D

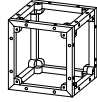

T-wave D-250

上面フレーム (D-250/D-1500)
top view
側面・正面フレーム (D-250)
side view/front view

P-6

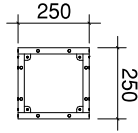

上面フレーム (D/D-500)
top view

P-6

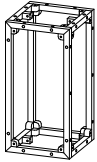
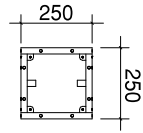

T-wave D-500

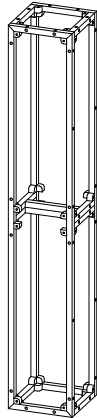

T-wave D-1500

側面・正面フレーム (D)
side view/front view

P-3

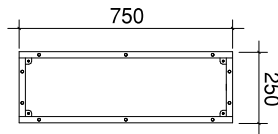

正面フレーム (D-500)
front view

P-5

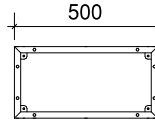

側面フレーム (D-500)
side view

P-5

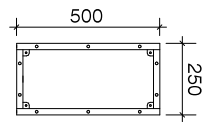

正面フレーム (D-1500)
front view

P-23

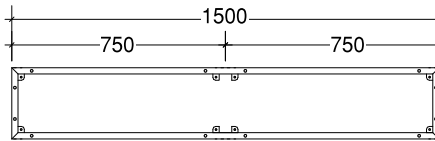

側面フレーム (D-1500)
side view

P-23

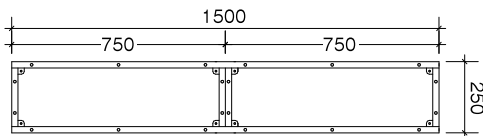

品名	重量 (kg)
T-wave D	3.33
T-wave D-250	2.33
T-wave D-500	3.18
T-wave D-1500	7.34

仕様サイズ(素材: A6061-T5/主材断面: □22×T3.3)

T-wave E-250 / E-750 (φ1500 1/8)

P-0 の使用パネルはT-12~T-14に記載してあります。

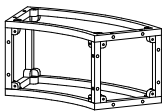

T-wave E-250

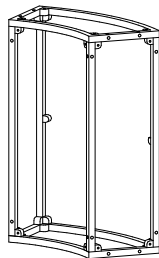

T-wave E-750

上面フレーム (E-250/E-750)
top view

P-24

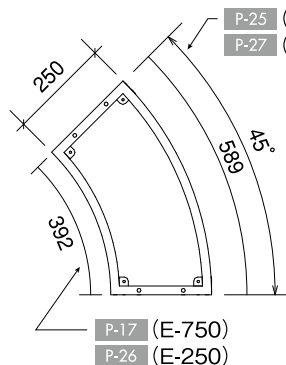

P-25 (E-750)
P-27 (E-250)

P-17 (E-750)
P-26 (E-250)

側面フレーム (E-750)
side view

P-3

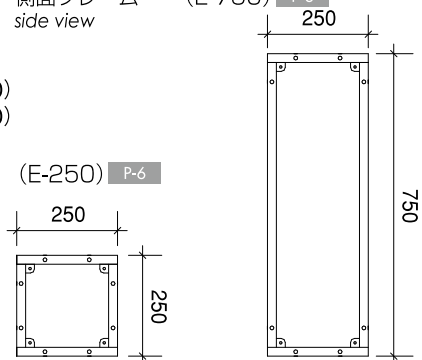

(E-250) P-6

品名	重量 (kg)
T-wave E-250	3.20
T-wave E-750	4.58

仕様サイズ(素材: A6061-T5/主材断面: □22×T3.3)

T-wave F / F-750

P-0 の使用パネルはT-12~T-14に記載してあります。

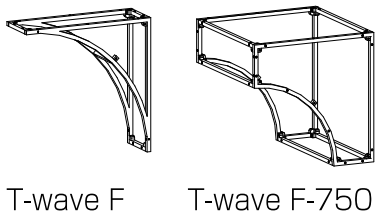

品名	重量 (kg)
T-wave F	3.79
T-wave F-750	6.77

仕様サイズ(素材: A6061-T5/主材断面: □22×T3.3)

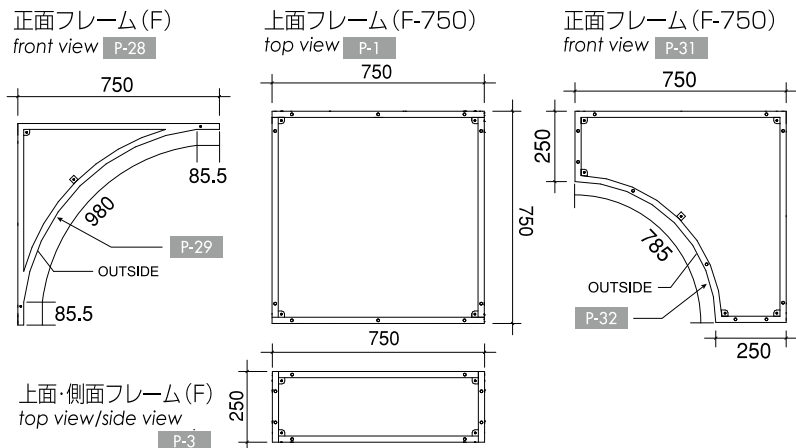

T-wave G / G-250 (φ5000 1/16)

P-0 の使用パネルはT-12~T-14に記載してあります。

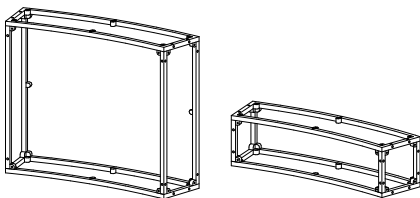

T-wave G T-wave G-250

品名	重量 (kg)
T-wave G	5.66
T-wave G-250	4.28

仕様サイズ(素材: A6061-T5/主材断面: □22×T3.3)

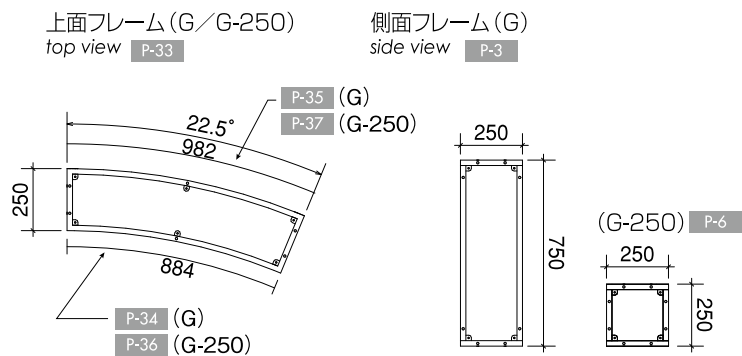

T-wave H / I

P-0 の使用パネルはT-12~T-14に記載してあります。

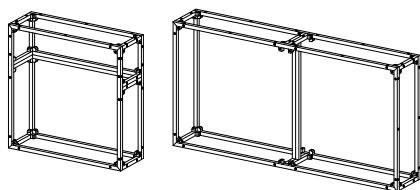

T-wave H T-wave I

品名	重量 (kg)
T-wave H	6.50
T-wave I	8.50

仕様サイズ(素材: A6061-T5/主材断面: □22×T3.3)

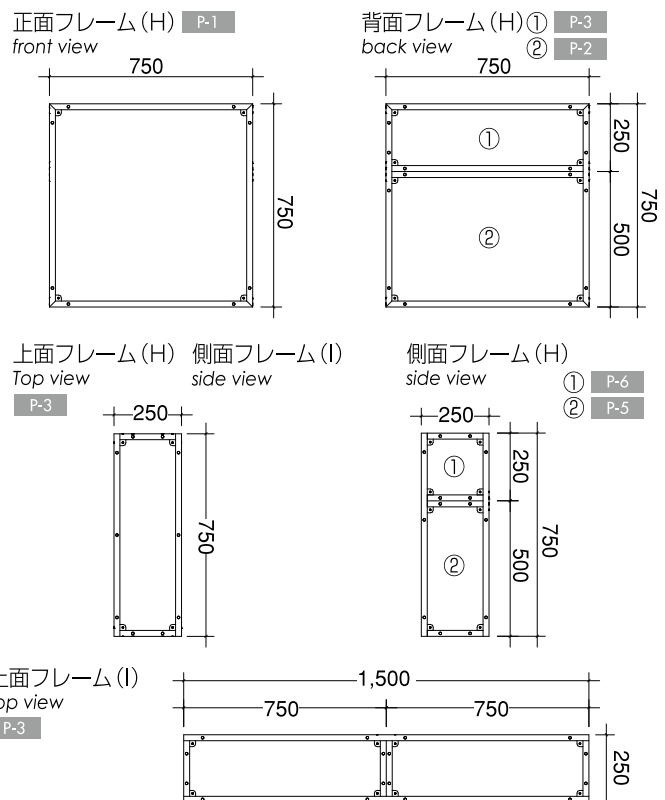

正面フレーム (I) 背面フレーム (I) P-30
front view back view

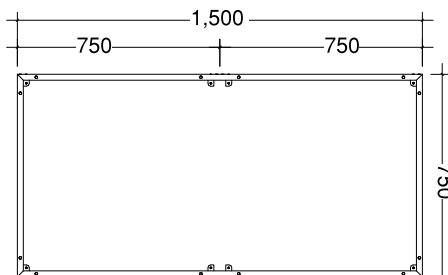

最大パネル厚 5mm / 穴サイズ φ11mm

T-wave K

P-0 の使用パネルはT-12~T-14に記載してあります。

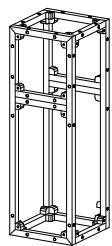

T-wave K

品名	重量 (kg)
T-wave K	4.95

仕様サイズ<素材: A6061-T5/主材断面: □22×T3.3>

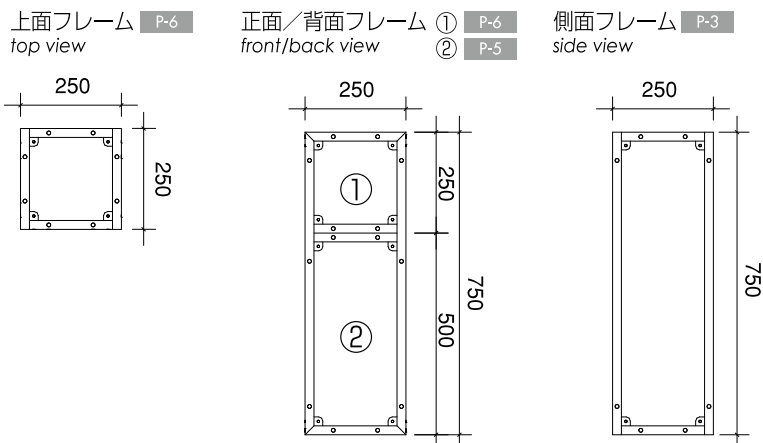

T-wave L -250

P-0 の使用パネルはT-12~T-14に記載してあります。

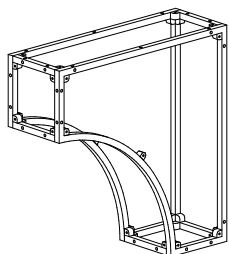

T-wave L -250

品名	重量 (kg)
T-wave L -250	5.34

仕様サイズ<素材: A6061-T5/主材断面: □22×T3.3>

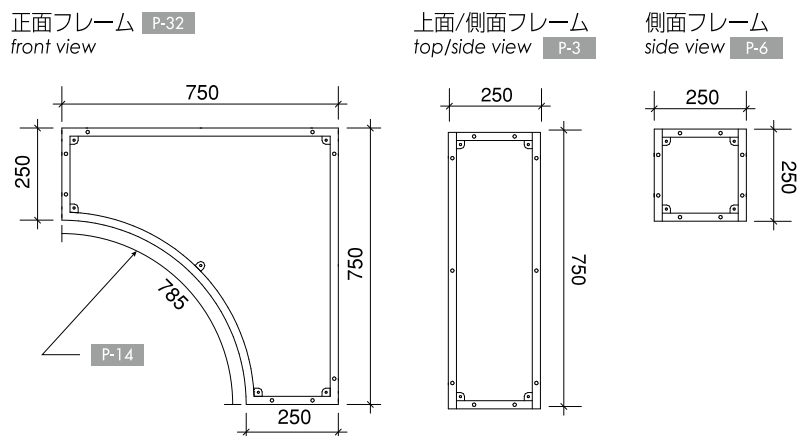

T-wave M-500

P-0 の使用パネルはT-12~T-14に記載してあります。

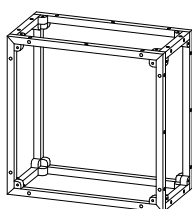

T-wave R-500

品名	重量 (kg)
T-wave M-500	3.80

仕様サイズ<素材: A6061-T5/主材断面: □22×T3.3>

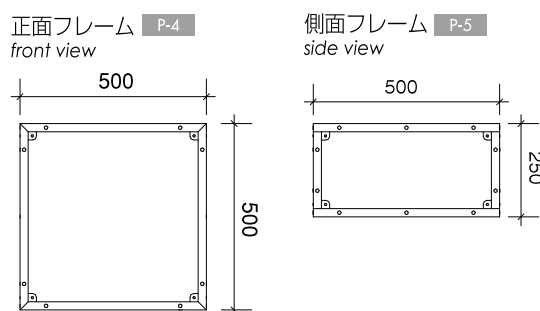

T-wave OW-250

P-0 の使用パネルはT-12~T-14に記載してあります。

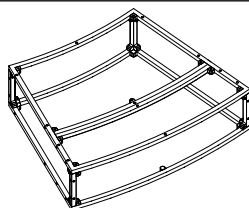

T-wave OW-250

品名	重量 (kg)
T-wave OW-250	6.5

仕様サイズ<素材: A6061-T5/主材断面: □22×T3.3>

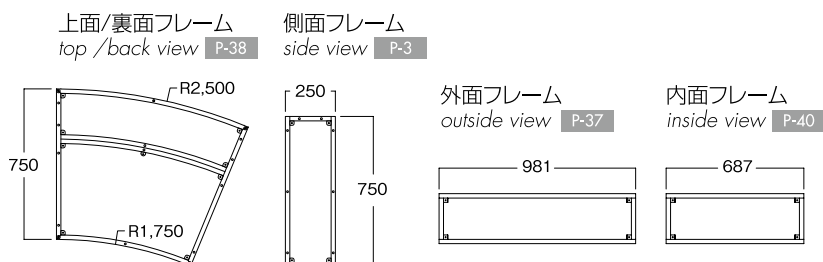

T-wave R-500/R-750

P-0 の使用パネルはT-12~T-14に記載してあります。

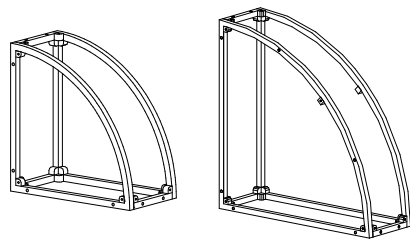

T-wave R-500 T-wave R-750

品名	重量 (kg)
T-wave R-500	3.28
T-wave R-750	5.50

仕様サイズ(素材: A6061-T5/主材断面: □22×T3.3)

正面フレーム
front view

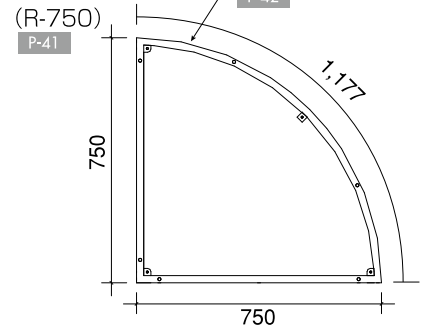
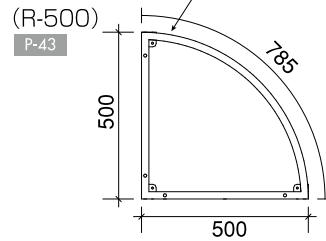

側面フレーム
side view

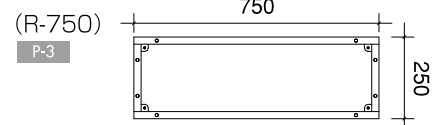
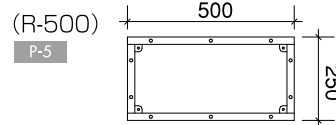

T-wave S/S-250 (φ3000 1/8)

P-0 の使用パネルはT-12~T-14に記載してあります。

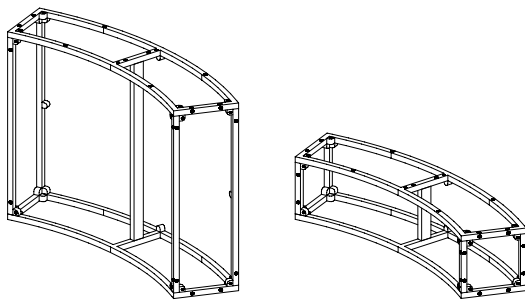

T-wave S T-wave S-250

品名	重量 (kg)
T-wave S	8.7
T-wave S-250	6.7

仕様サイズ(素材: A6061-T5/主材断面: □22×T3.3)

上面フレーム (S/S-250)
top view

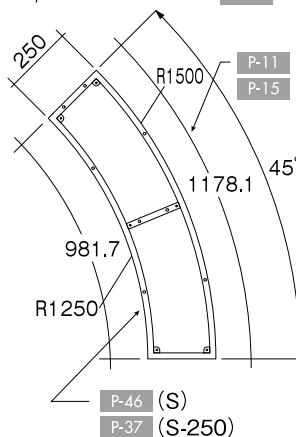

側面フレーム
side view

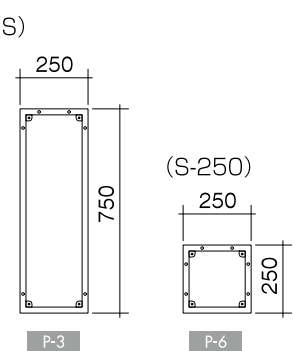

T-wave TR-250/TR-750

P-0 の使用パネルはT-12~T-14に記載してあります。

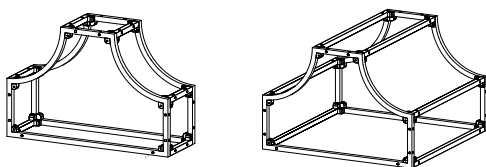

T-wave TR-250 T-wave TR-750

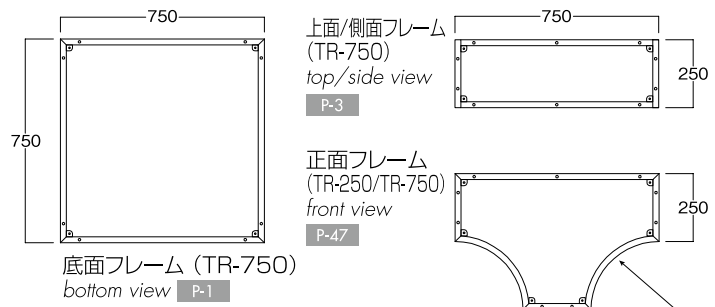

底面フレーム (TR-250)
bottom view

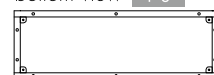

上面/側面フレーム (TR-250)
top/side view

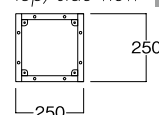

P-17 (TR-750)
P-26 (TR-250)

品名	重量 (kg)
T-wave TR-250	4.67
T-wave TR-750	6.5

仕様サイズ(素材: A6061-T5/主材断面: □22×T3.3)

最大パネル厚 5mm/穴サイズ φ11mm

T-wave Y-250 / YB-250

P-0 の使用パネルはT-12~T-14に記載してあります。

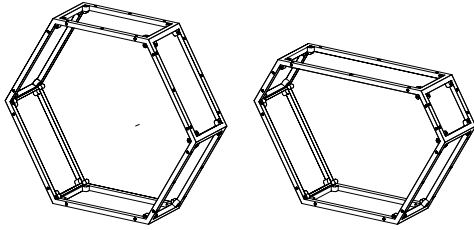

T-wave Y-250 T-wave YB-250

品名	重量 (kg)
T-wave Y-250	5.54
T-wave YB-250	5.24

仕様サイズ(素材: A6061-T5 / 主材断面: □22×T3.3)

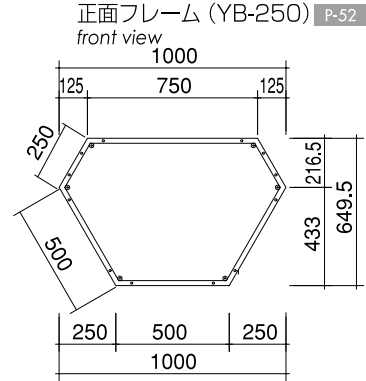
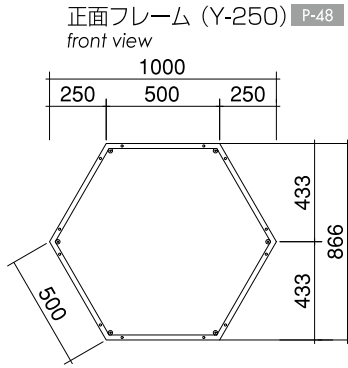

上面・底面フレーム (Y-250)
Top view/bottom view

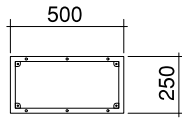

底面フレーム (YB-250)
bottom view

P-5

上面フレーム (YB-250)
Top view



P-3

T-wave YC-250

P-0 の使用パネルはT-12~T-14に記載してあります。

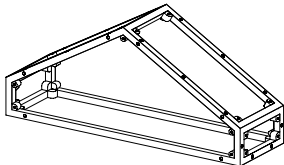

T-wave YC-250

品名	重量 (kg)
T-wave YC-250	4.12

仕様サイズ(素材: A6061-T5 / 主材断面: □22×T3.3)

正面フレーム P-49
front view

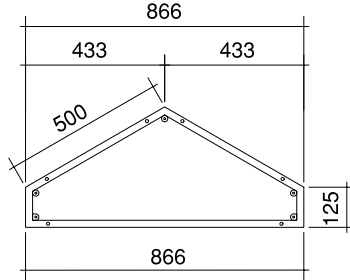

側面フレーム P-51
side view

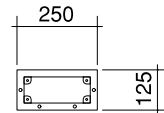

底面フレーム
bottom view

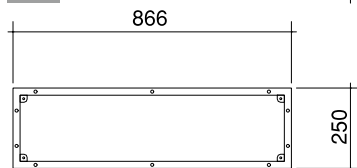

P-50

T-wave YD-250 / YF-250

P-0 の使用パネルはT-12~T-14に記載してあります。

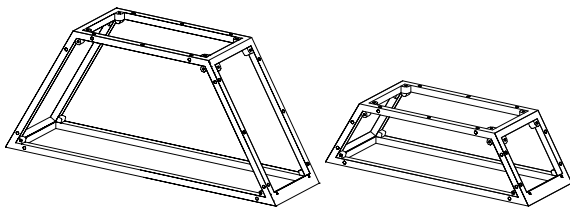

T-wave YD-250

T-wave YF-250

品名	重量 (kg)
T-wave YD-250	4.12
T-wave YF-250	3.16

仕様サイズ(素材: A6061-T5 / 主材断面: □22×T3.3)

底面フレーム (YD-250) P-53
bottom view

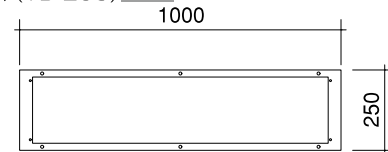

底面フレーム (YF-250) P-3
bottom view

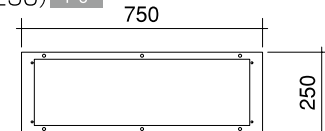

上面フレーム (YD-250/YF-250) P-5
Top view

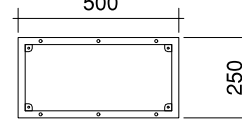

正面フレーム (YD-250) P-55
front view

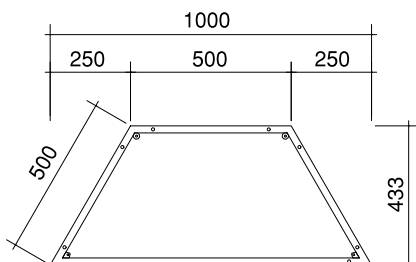

正面フレーム (YF-250) P-54
front view

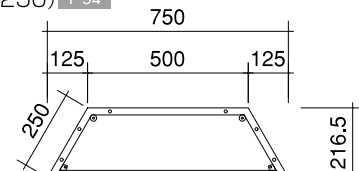

LED PANEL

タイプ A
type A

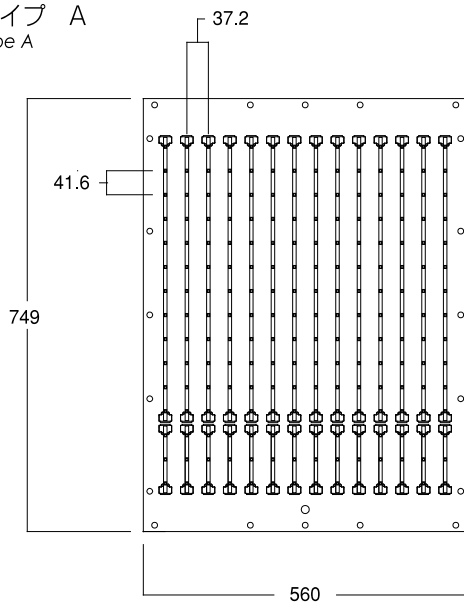

タイプ D
type D

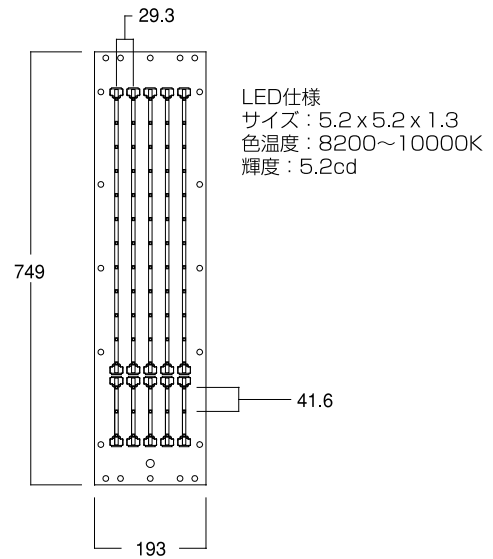

LEDパネル製品仕様

名称	タイプ A	タイプ D
使用電源	AC 100V	AC 100V
製品サイズ ()	749x560x (最大部) 37	749x193x (最大部) 37
消費電力 (W)	50	30
重量 (kg)	1.7	0.8
LEDチップ	3CHIP 210個	3CHIP 75個
ACアダプタ《PSE》	AC100V-DC12V	AC100V-DC12V
直列接続	最大 10枚まで	最大 10枚まで

X-BAR

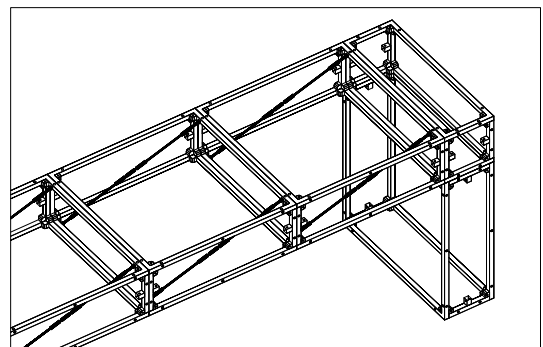
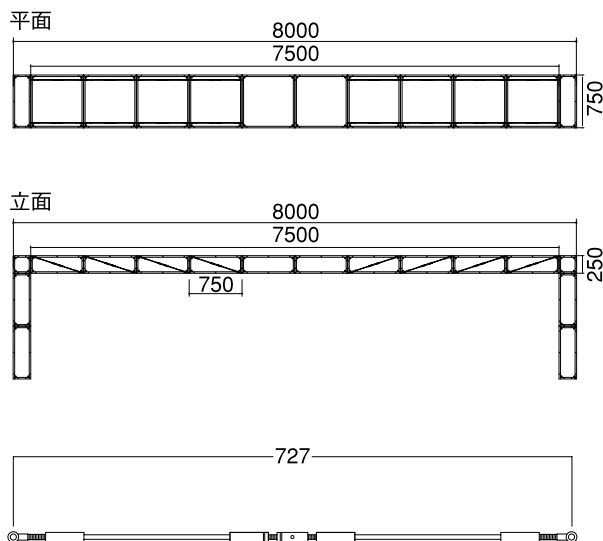

X-BARはT-WAVEを補強し、たわみを解消、安全にデザインの世界を広げることができる補強パーツです。いままでは難しかった長いブリッジやタワー、広い天井と使い方は自由自在で新しいT-WAVEの世界がまた広がります。

最大使用荷重及びたわみ量(等分布荷重)

荷重 = (WAVE本体+LED+吊り下げ許容重量)

	スパン(m)	吊り下げ許容重量(kg)	たわみ量(mm)	荷重(kg)
	3m	64	11	90
	4.5m	11	19	50
	5.25m	0	21	45
	6m	0(LED取付け不可)	22	40

荷重 = (WAVE本体+LED+吊り下げ許容重量)

	スパン(m)	吊り下げ許容重量(kg)	たわみ量(mm)	荷重(kg)	
	3m	33	16	50	
	3.75m	15	18	35	
	4.5m	5	24	30	
		スパン(m)	吊り下げ許容重量(kg)	たわみ量(mm)	荷重(kg)
		3m	24	16	50
	3.75m	2.5	18	35	

最大スパン例

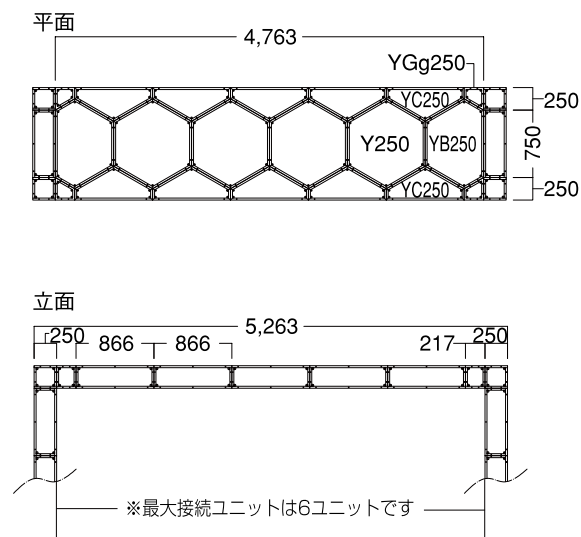
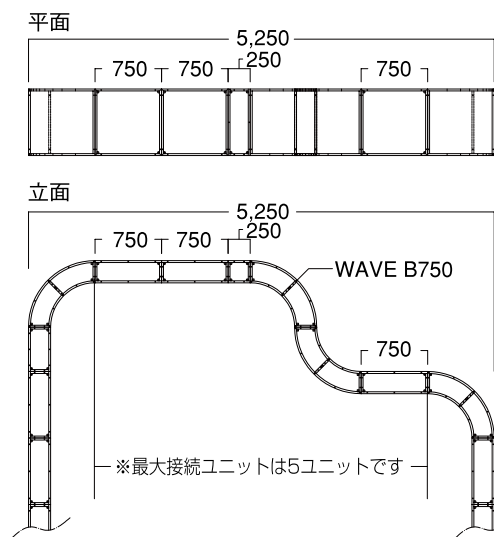
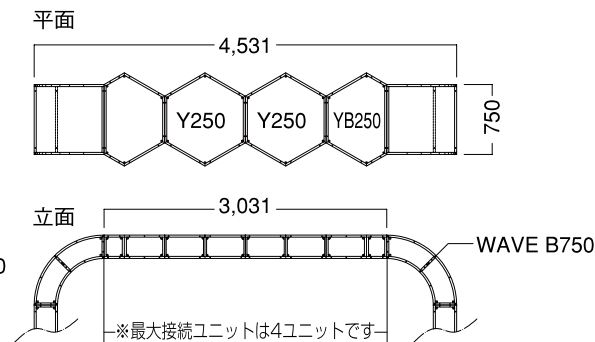
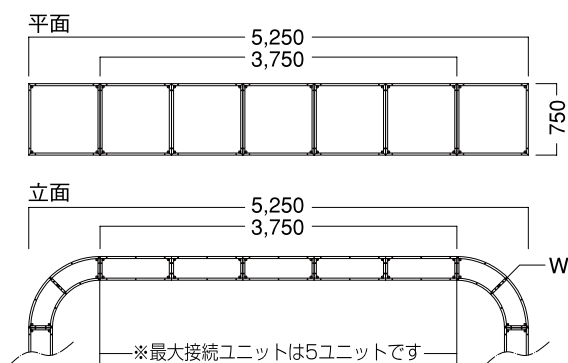

PANEL

共通パネル

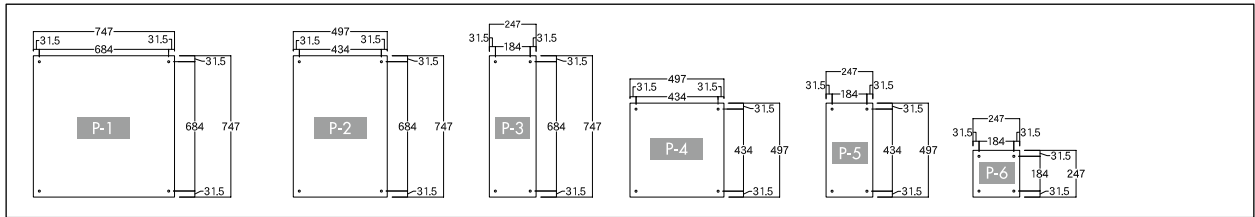

A2250/A3000

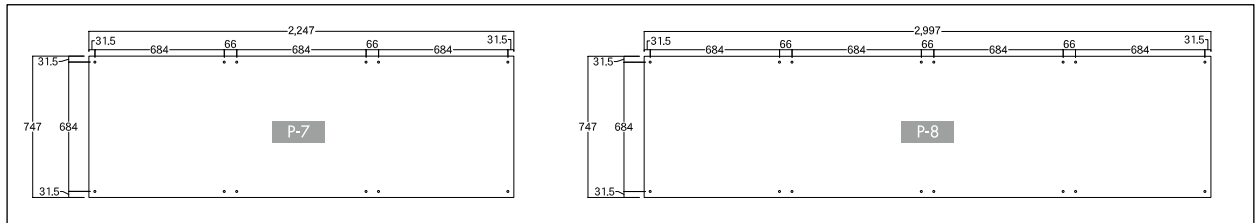

B用

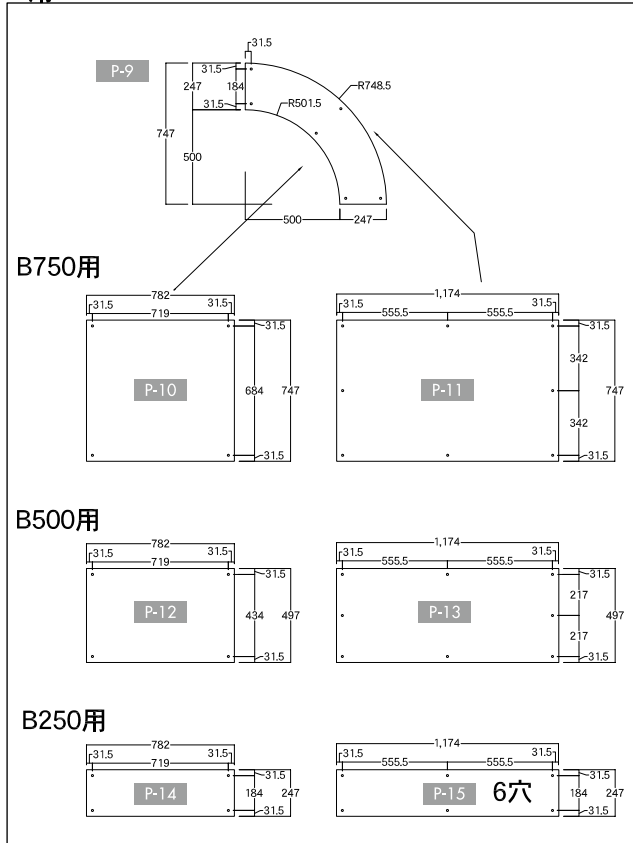

BR用

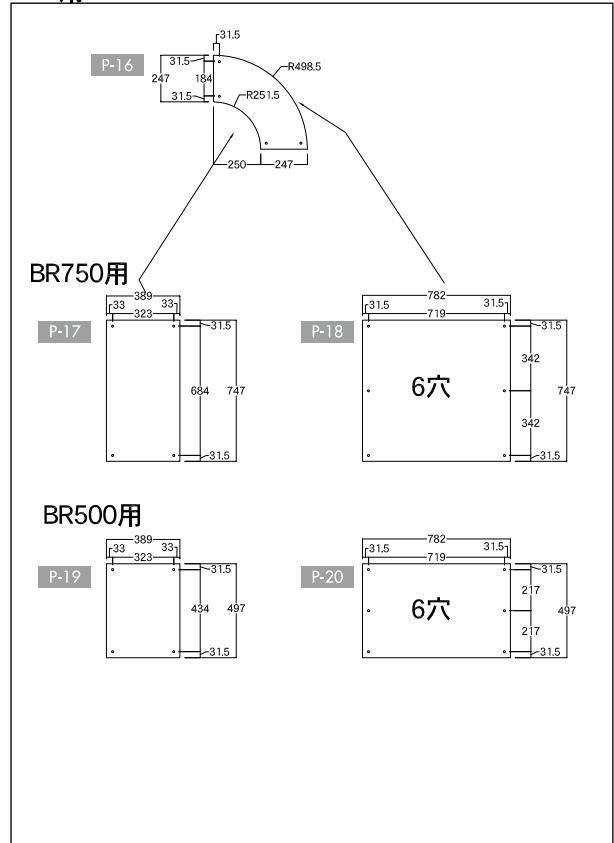

C専用

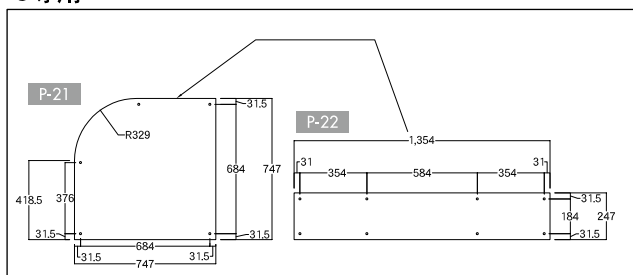

D1500専用

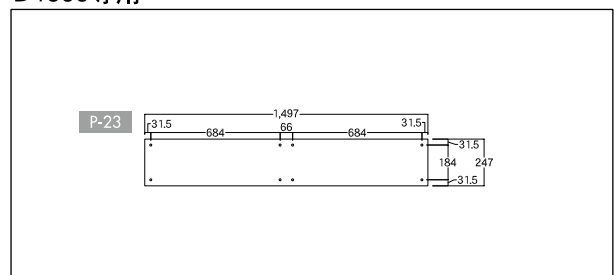

PANEL

E用

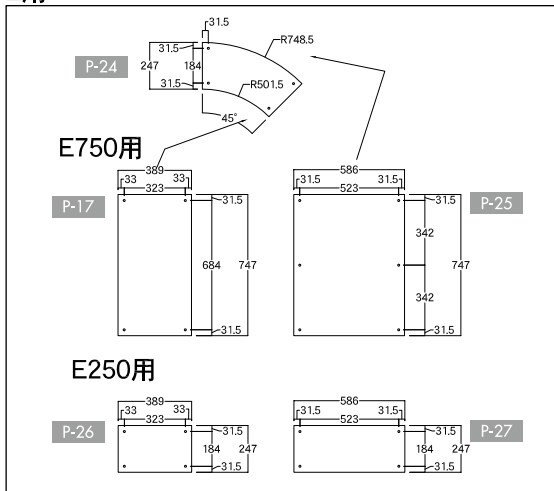

F・L用

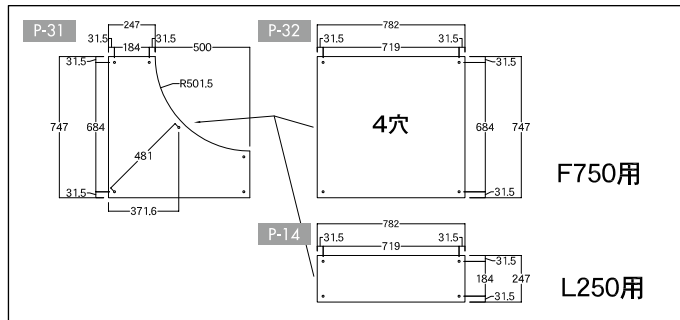

G用

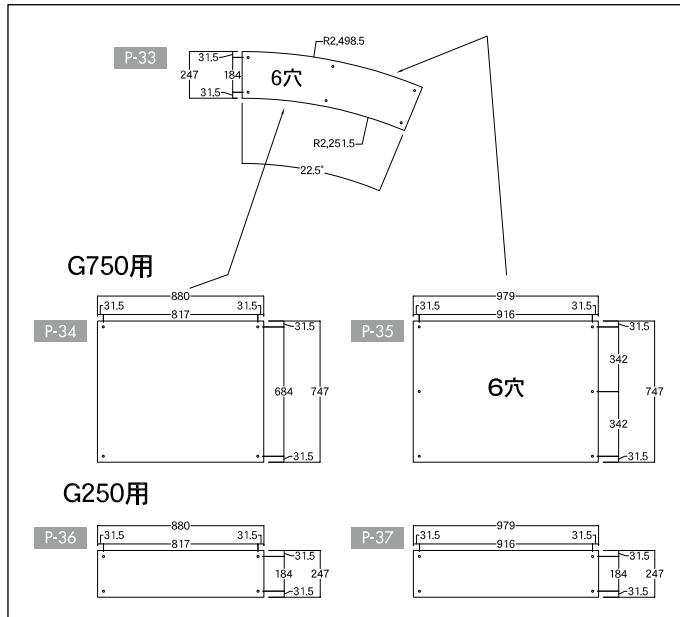

F専用

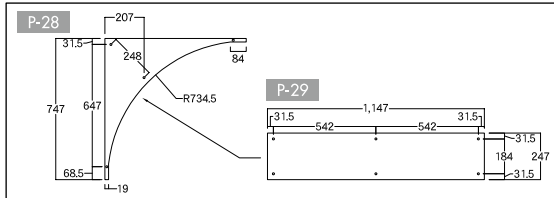

I専用

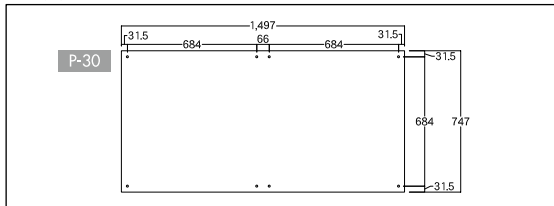

OW用

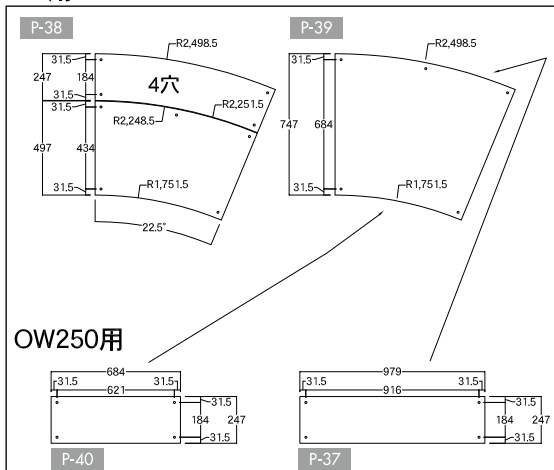

R750専用

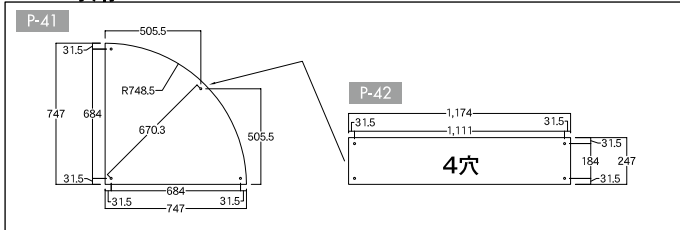

R500専用

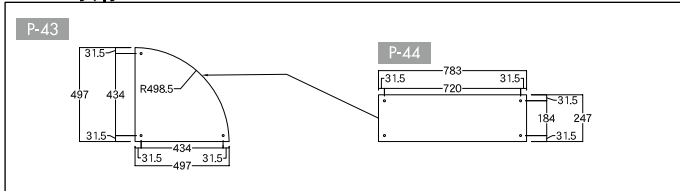

450シリーズ用

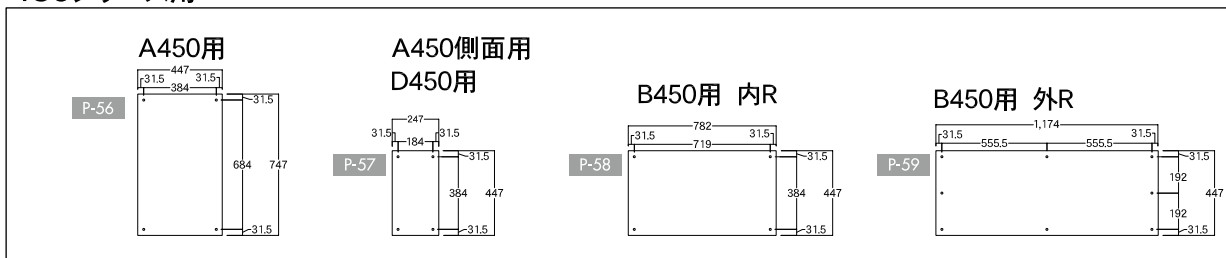

S用

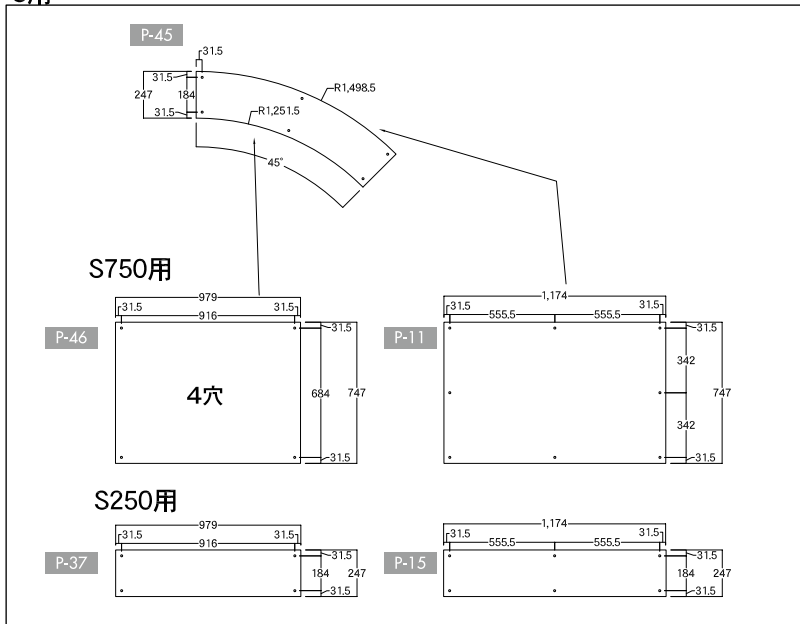

TR用

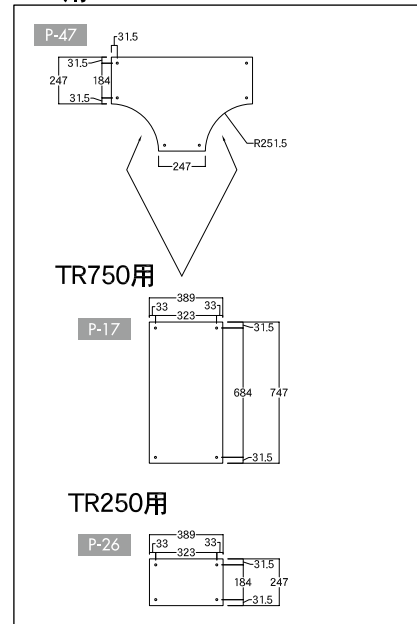

Y用

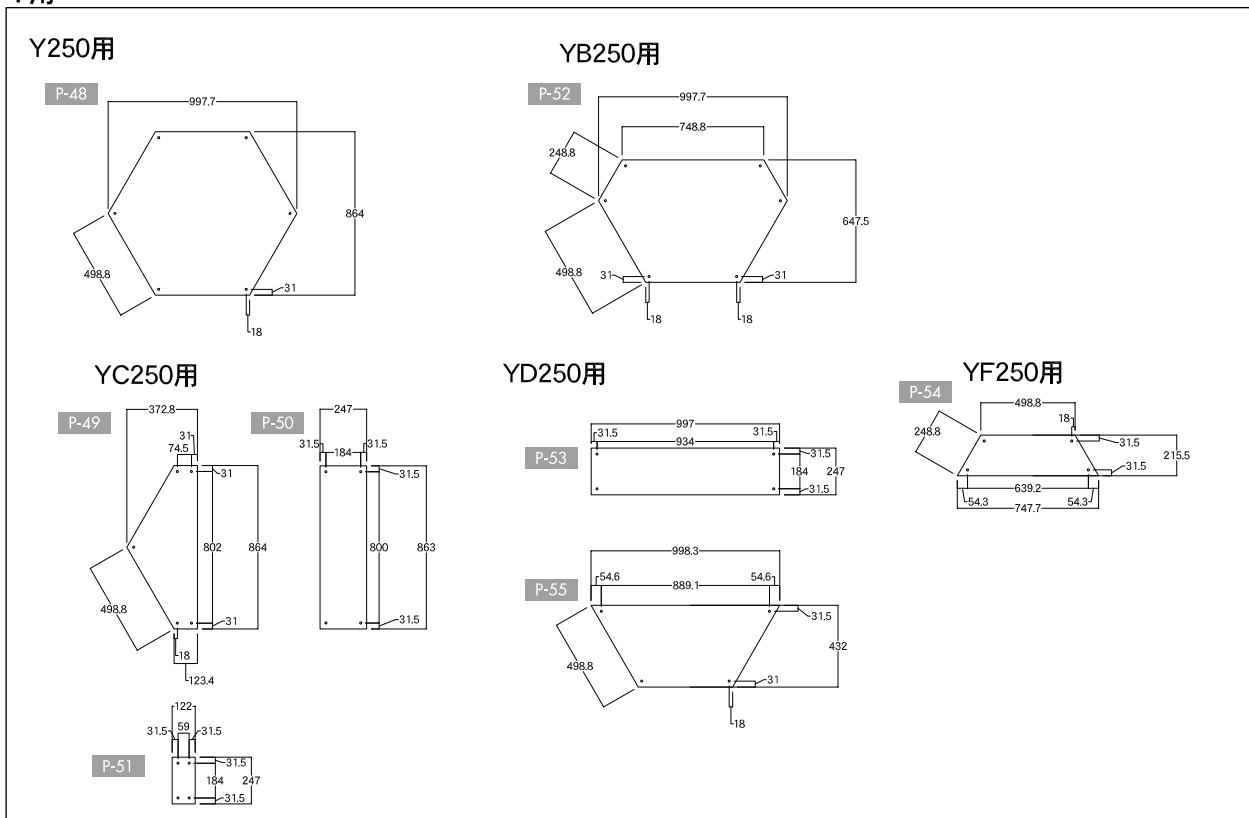

E450用 内R

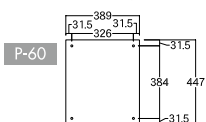

E450用 外R

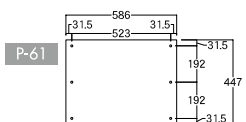

G450用 内R

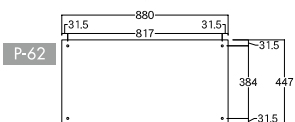

G450用 外R

